

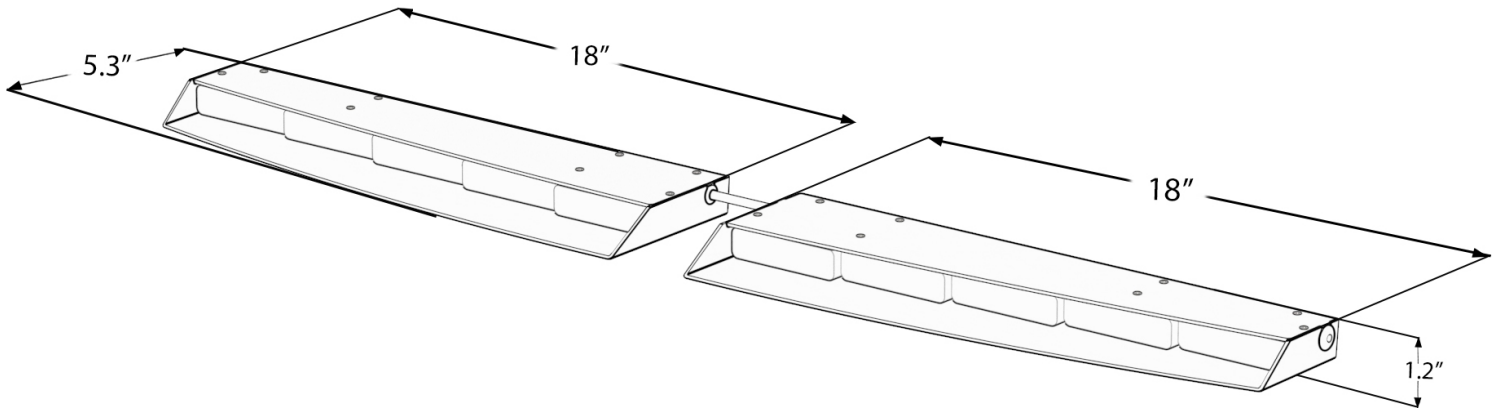

RAPTOR® SUPER TD VISOR LIGHT BAR



B-RTSTD10

INSTRUCTION MANUAL



RAPTOR® SUPER TD VISOR LIGHT BAR

Warnings and Notices for Users and Installers

This document must be delivered to and read by the end user and installer as it serves to provide you with the required information for proper and safe use of your STL product. Before operating this or any STL products the user and installer must read this manual all the way through. You will find important information in this manual that could prevent property damage and/or serious injury to the user and installer.

STL products are intended to alert pedestrians and other operators of the presence of personnel, the operation of emergency vehicles, an emergency site, and any warning needs. This does not ensure that pedestrians or drivers will react, heed, or observe emergency warning signals. Nor does the use of emergency signals grant or ensure you the right of way. It is your responsibility to make sure you can proceed safely before driving against traffic, entering an intersection, responding at a high rate of speed, or walking on or around traffic lanes.

Your STL emergency vehicle devices should be tested daily to ensure the device and all its functions are operating correctly. If you experience a malfunction contact STL's Customer Service immediately for troubleshooting options, or a warranty or service claim. You must ensure that the projection of the visual and audible signal is not blocked by vehicle components (i.e.: open trunks, visors, compartment doors), vehicles, other obstructions, or people.

This is professional grade equipment and is intended for strict use by authorized personnel only. It is the user's responsibility to understand and obey all laws regarding emergency warning devices. You must know and be familiar with all applicable city, state, and federal laws and regulations prior to the use of emergency vehicle warning devices.

SpeedTech Lights, Inc assumes no liability for any loss resulting from the use of this warning device. Proper installation is vital to the performance of the warning devices and safe operation of the emergency vehicle. Since the operator is under stressful environments the equipment must be properly wired and mounted to ensure effectiveness and safety. Therefore controllers must be properly installed and placed within convenient reach of the operator so eye contact with the roadway is never lost.

The effectiveness of your STL equipment is highly dependent upon correct mounting and wiring. Improper wiring and mounting of the warning device will reduce the output and performance of the equipment. Emergency warning devices frequently require high electrical voltages and/or currents. Properly protect and use caution around live electrical connections. Grounding or shorting of electrical connections can cause high current arcing, which can cause severe personal injury and/or serious vehicle damage, including fire.

Electromagnetic interference can be caused by many electronic devices used in emergency vehicles. To ensure that this doesn't happen to you, Light Bars should be mounted a minimum of 12" - 34" from the radio antenna and do not power your equipment from the same circuit or share the same grounding circuit with radio communication equipment. After installation, test all the vehicle's equipment together to ensure everything operates free of interference.

Driver and/or passenger airbags (SRS) will impact the way you mount your equipment. Any equipment installed in the deployment area of the airbags will damage or dislodge the airbags and sensors. This will also reduce the effectiveness of the airbags to protect the passengers and therefore these areas must be avoided. Installers must make sure that this equipment along with any parts, hardware, wiring, power supplies, and switch boxes do not interfere with the airbags, SRS wiring, or sensors.

All STL equipment needs to be mounted and installed according to the vehicle manufacturer's instructions and securely attached to a part of the vehicle of sufficient strength to withstand the forces applied by the equipment. This device should be permanently mounted within the zones specified by the vehicle manufacturer. This especially applies to equipment mounted on the exterior of the vehicle to avoid dislodging. Mounting units on the interior of the vehicle by a method other than permanent mount is discouraged as it may become detached under aggressive driving conditions such as sudden braking, collision, or swerving.

PROPER INSTALLATION COMBINED WITH OPERATOR TRAINING IN THE PROPER USE OF EMERGENCY WARNING DEVICES IS ESSENTIAL TO ENSURE THE SAFETY OF EMERGENCY PERSONNEL AND THE PUBLIC.

Unpacking Your STL Product

- Unpack your unit to identify all parts including but not limited to: Light Bar, switch box, brackets, screws, bolts, wiring harness, fuses, etc.
- Some parts may be in small bags.
- Some products may be packaged inside boxes of other products.
- Some parts such as Gutter Brackets, may be in the foam protection. Double check that no parts are left within the foam protection or left in the box.



RAPTOR® SUPER TD VISOR LIGHT BAR

Important Points for Your Safety and Longevity of Your Light Bar

- Installers are required to have a good understanding of automotive electronic systems and procedures for proper installation.
- Never stare directly into the LEDs as momentary blindness and/or eye damage may occur.
- Never take any lights through a car wash. Use only water to clean the outer body/lens of your equipment.
- Never use a pressure washer to clean any STL products. Inspect and test your product daily to ensure it operates properly and is mounted correctly.
- Never cut wires or work on a unit while the unit is still connected to a power source.
- Never install this product or route any wires through or in the deployment area of the airbag. Doing so may cause serious personal injury as it will damage or reduce the effectiveness of the airbag by causing the unit to become a projectile. Reference the owner's manual for your vehicle to find the airbag deployment area. The User/Installer assumes all responsibility to determine proper mounting location, based on providing ultimate safety to all passengers in the vehicle.
- If the product requires you to drill holes, the installer must ensure that the drilling process does not damage any vehicle components or other vital parts. Check all sides of the mounting surface before beginning to drill. Make sure to deburr all drilled holes and remove any metal remnants or shards to avoid injury and wires from becoming spliced. Grommets are to be installed in all wire passage holes.
- Grommets, cable ties, looms, and other installation hardware should be used to anchor and protect all wiring. Fuses should be properly sized and located as close to the power take off points as possible to protect the wiring and device. To protect against short circuits, a fuse is included by STL for all products. DO NOT use a fuse with a higher amp rating than the initial fuse included by STL for all products.
- Insulation displacement connectors are not to be used.
- In order for STL products to operate at optimum efficiency, a secure and good electrical connection to the battery's Ground Post must be made. The recommended procedure requires the unit's ground wire be connected directly to the NEGATIVE (-) battery post. DO NOT use Circuit Breaks.
- Instruction manuals should be stored in a safe place for reference if you need to reinstall the unit or perform maintenance. They can also be found at the main site under the product listing at www.SpeedTechLights.com. If your product is no longer available on the website contact STL's Customer Service at 800-757-2581 for assistance.
- If your product requires the use of a control box or remote device to turn on and control your equipment, make sure it is installed in a location that allows both the user and the vehicle to operate safely in any driving condition.
- Never activate or control your equipment in hazardous driving conditions.
- Use SXL type wire in the engine compartment where higher heat resistance is required according to SAE J-1128. All wires should be in accordance with the minimum wire size and other recommendations made by the manufacturer and be protected from hot surfaces and moving parts.
- FAILURE TO FOLLOW THESE SAFETY PRECAUTIONS, WARNINGS, NOTICES, AND INSTRUCTIONS COULD RESULT IN DAMAGE TO THE PRODUCT OR VEHICLE THAT WILL VOID YOUR WARRANTY AND/OR CAUSE SERIOUS INJURY TO YOU AND YOUR PASSENGER.

Pre-Installation and Testing

BENCH TEST all units prior to installation by connecting the Positive Cable (Red) and Negative Cable (Black) to a power source to ensure all the features and parts of the Light Bar are functional.

Test Check List:

- LED diode and LED Module functionality
- Flash patterns
- Non-volatile memory
- Physical damage

If you have trouble call Customer Service at 800-757-2581 before proceeding.

Maintenance

While STL's Light Bars are very durable, there are some things you need to keep in mind and practice to preserve the longevity and function of your Bar.

- Never take any STL Light Bars through a car wash, such as a pressure washer, automatic car wash, brushes that will scratch your equipment or similar car washes or equipment where chemicals, high pressure water, and materials may scratch or damage your equipment.
- Use Water (H₂O) with a soft cloth to clean your Light Bar and lenses.
- Yellowing of clear lenses may occur overtime. Lenses can be purchased by calling STL Customer Service at 800-757-2581.



RAPTOR® SUPER TD VISOR LIGHT BAR

Wiring Diagram

Wire Color	Function
Red*	Positive
Black*	Negative
Yellow	Flash Pattern
Brown	Flash Mode 2

* Indicates a main power cable.

Wire Color	Function
White	Flash Mode 1
Blue	Super Take Down Steady
Green	Take Down Steady

NOTE: All cables except Negative contact +12 VDC.

NOTE: Flash Mode 2 function can only be activated while Flash Mode 1 cable is receiving +12VDC too.

AUX Wiring Diagram

Wire Color	Function
White-	Control box back light *

* Only functional when using in conjunction with STL Grand Control Box (Sold separately)

Specifications

Voltage	12 VDC
Amps	< 4.2
Optic	TIR
LED Count	80
Cable Length	12' Light Bar Cable, 12.5' Power Cable
Cable Length Between Each Side	2.5'
Flash Patterns	26

Grand Control Switch Box Operation (Sold Separately)

Power Button:

- Push this button to turn On/Off the Direct Control Box.

Mode 1 Button:

- Activate warning function in flash pattern memory 1.

Mode 2 Button:

- Activate warning function in flash pattern memory 2.

Flash Pattern Button:

- Cycles to the next flash pattern with each press.
- Non-Volatile memory recalls the last flash pattern selected in each Mode.
- Hold for 3 seconds to toggle Steady Burn mode.
- Hold for 5 seconds to toggle Random pattern mode.

TD Button*:

- 1st press: TD Steady Burn On.
- 2nd press: TD Off.

Super TD Button*:

- 1st press: Super TD Steady Burn On.
- 2nd press: Super TD Off.
-

Night Button**:

- Activate back light LEDs in control box.

** Power Button does not need to be activated for these Buttons to function.*

*** Hardwire the free standing cable to your headlight +12VDC line to automate this feature. NOTE: Once hardwired, this button ceases to function. Make sure the Night button is NOT toggled before doing this step otherwise the button will constantly remain activated.*

Extension Cable (Sold Separately)

- If you have an extension cable with connectors, connect the corresponding ends to one another. Use the connector at the end of the cable to plug into the control box.
- If you have an extension cable with one connector, you will need to cut the connector off of the main cable harness coming out of the Light Bar. Save it as a spare part. You will solder and heat shrink each wire within the cable harness to each wire in the extension cable harness. DO NOT cross connect wires. Use the connector at the end of the extension cable to plug into the control box.
- If you have an extension cable with no connectors, you will need to cut in the middle of the main cable harness coming out of the Light Bar. You will solder and heat shrink each wire within the cable harness to each wire in the extension cable harness. DO NOT cross connect wires. Use the reattached connector from the end of the main cable harness to plug into the control box.
- NOTE: DO NOT leave connectors, cables, solder points exposed to heat, moisture, or debris.
- NOTE: When adding the extension cable, only the AUX and White cable on the extension cable will be functional. Main bar harness connections will cease to function.

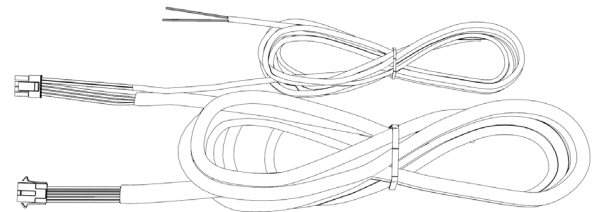
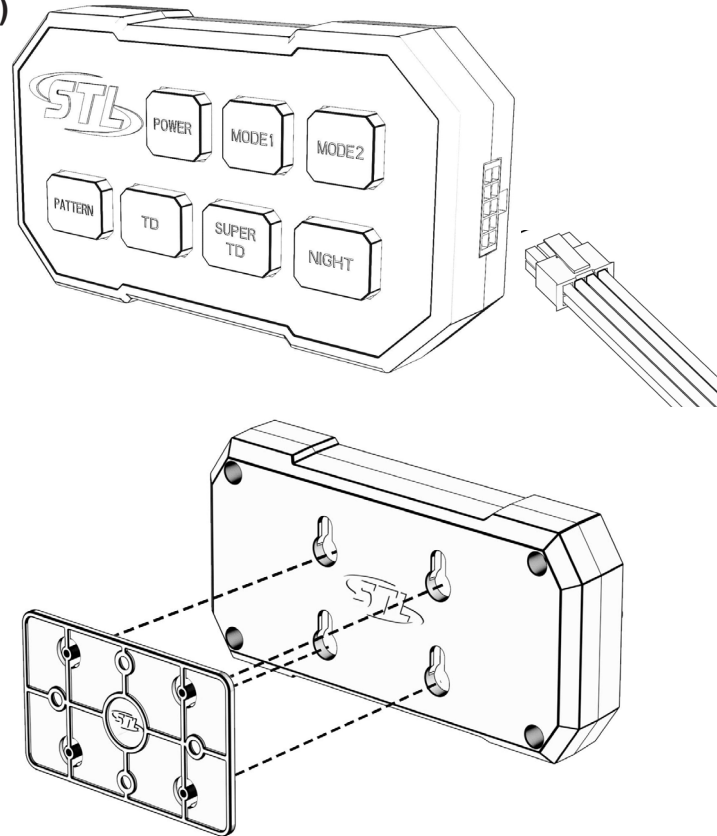

Available Visor Bracket Mounts

**Q-RVT15: Chevy Tahoe/
Silverado GMC Sierra/
Yukon
(2015+)**

Driver
Side



Passenger
Side



Center

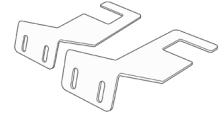

**Q-RVT07: Chevy Tahoe/
Silverado GMC Sierra/
Yukon
(2007-2014)**

Driver
Side



Passenger
Side



Center

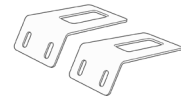

**Q-RVC11: Dodge Charger
(2011+)**

Driver
Side



Passenger
Side



Center

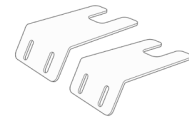

**Q-RVR15: Dodge Ram
(2015+)**

Driver
Side



Passenger
Side



Center

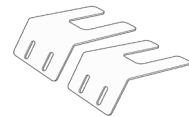

**Q-RVIT11: Ford Taurus/
Interceptor
(2011+)**

Driver
Side

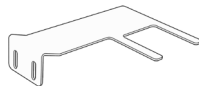

Passenger
Side



Center

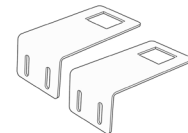

**Q-RVD15: Dodge Durango
(2015+)**

Driver
Side



Passenger
Side

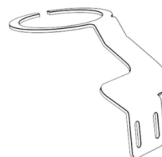

Center

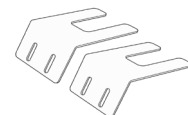

RAPTOR[®] SUPER TD VISOR LIGHT BAR

Available Visor Bracket Mounts

Q-RVEX18: Ford Expedition (2018+)

Driver
Side

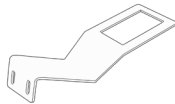

Passenger
Side

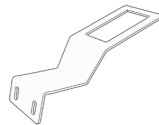

Center

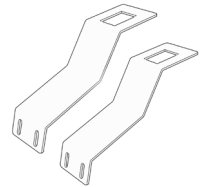

Q-RVF15: Ford F-150 (2015+) Super Duty (2017+)

Driver
Side



Passenger
Side

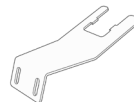

Center

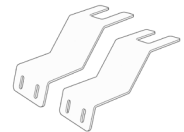

Q-RVE11: Ford Explorer (2011-2019)

Driver
Side



Passenger
Side

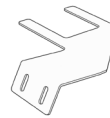

Center

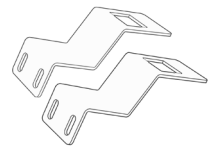

Q-RVE20: Ford Explorer (2020+)

Driver
Side



Passenger
Side



Center

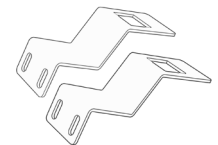

Q-RVU: Universal

Short
Fork

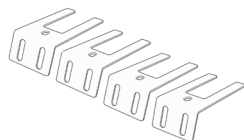

Long
Fork

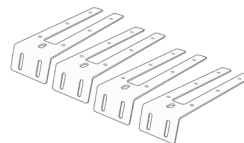

Base

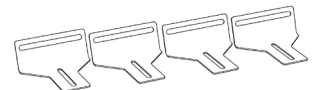

Mounting Bracket Contents

Inspect contents of package before proceeding.

Q-RVU Universal Bracket (Included)	Q-RVxx Vehicle Specific Brackets (Sold Separately)
<p>Universal Brackets:</p> <ul style="list-style-type: none"> • (4) Universal long forked visor brackets • (4) Universal short forked visor brackets • (4) Base brackets (Not always used) <p>Universal Bracket Hardware Contents:</p> <ul style="list-style-type: none"> • (8) Philips pan head screws • (8) Split lock washers • (8) Hex nuts • (8) Flat washers • (4) Philips pan head short bolts • (4) Flat large diameter washers • (4) Large diameter split lock washers • (2) Rubber protective strips 	<p>Vehicle Specific Brackets:</p> <ul style="list-style-type: none"> • (1) Driver side bracket • (1) Passenger side bracket • (2) Center brackets <p>Vehicle Specific Bracket Hardware Contents:</p> <ul style="list-style-type: none"> • (8) Philips pan head short bolts • (8) Flat washers • (8) Split lock washers • (2) Rubber protective strips <p>NOTE: Universal Bracket is also included with the Vehicle Specific brackets. Base brackets may be used for additional adjustability.</p>

Q-RVU Universal Mounting Bracket Installation

Rear Track Mounting:

1. Take (2) sets of the Philips pan head screws and slide them into the rear track of the unit.
2. Choose any combination of long and/or short forked visor brackets and align them so that the screws line up with the tracks of the bracket.
3. Use (2) flat washers, (2) split lock washers, and (2) hex nuts to secure each bracket set to the unit.
4. Apply the included rubber protective strips to prevent windshield chatter.
5. Now position the forks to line up with your visor joints and secure.

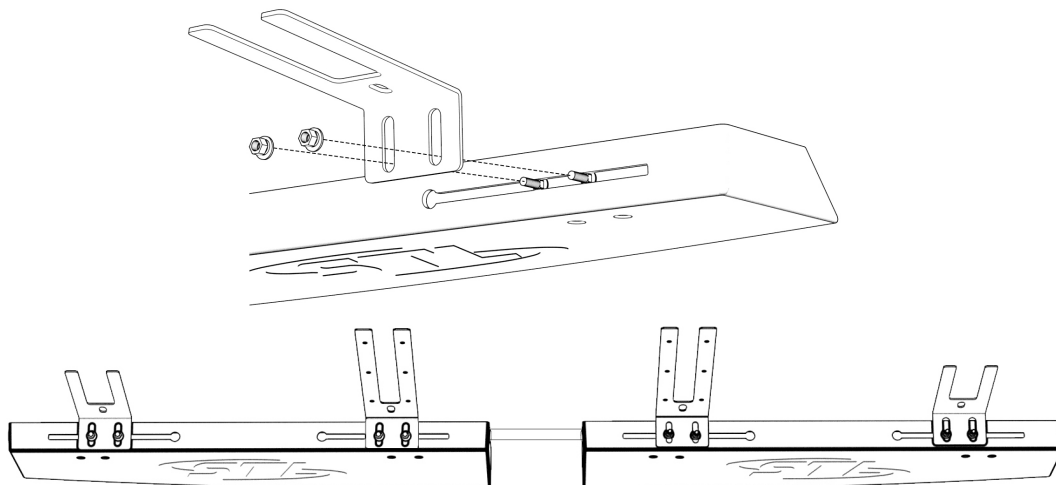

RAPTOR[®] SUPER TD VISOR LIGHT BAR

Base Bracket Mounting:

NOTE: Mounting the light bar by attaching the forks directly to rear track may position the unit too far away from the windshield in certain vehicles. If this is the case for your vehicle, see below alternate mounting instructions using the (4) Base brackets:

1. Take the (4) Philips pan head short bolts and attach the (4) Base brackets to the mounting holes on the bottom of the unit using the (4) flat large diameter washers and (4) large diameter split lock washers.
2. Choose any combination of long and/or short forked visor brackets and align them so that the screws line up with the tracks of the Base bracket.
3. Attach the forked visor brackets to the Base bracket using the (8) Philips pan head screws, (8) split lock washers, (8) hex nuts and (8) flat washers.
4. Now you will be able to adjust the unit laterally as well as front to back in order to position the forks to line up with your visor joints and secure.

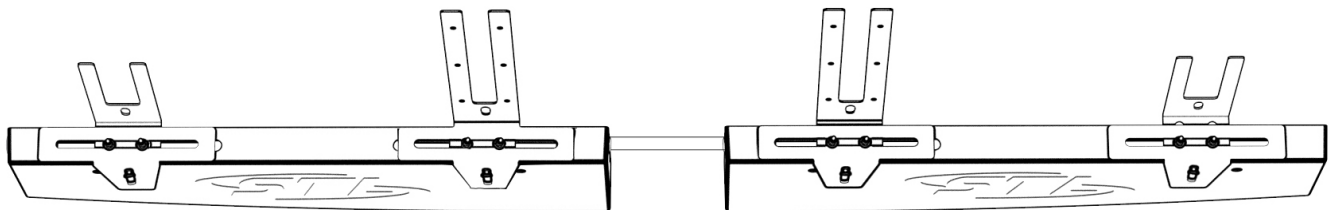
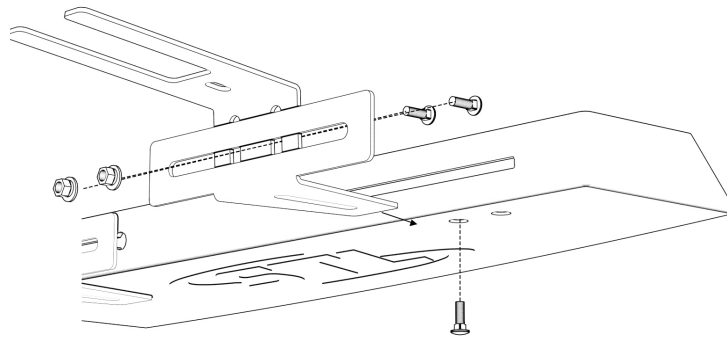

NOTE: All vehicle specific brackets have the same mounting versatility as above. See exhibits below:

RAPTOR[®] SUPER TD VISOR LIGHT BAR

Q-RVF15: Ford F-150 (2015+) Ford Super Duty (2017+)

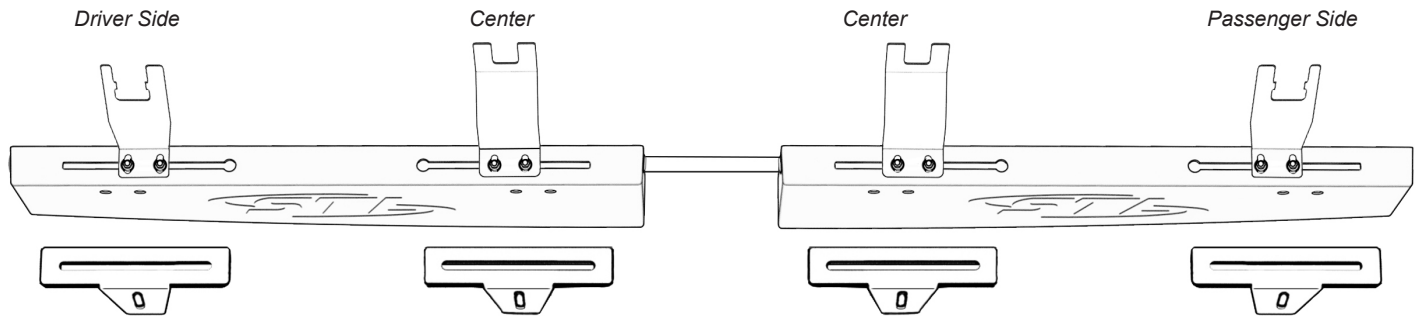

NOTE: Universal Base bracket can also be added for additional lateral and/or forward adjustment if necessary.

Q-RVE11: Ford Explorer (2011-2019)

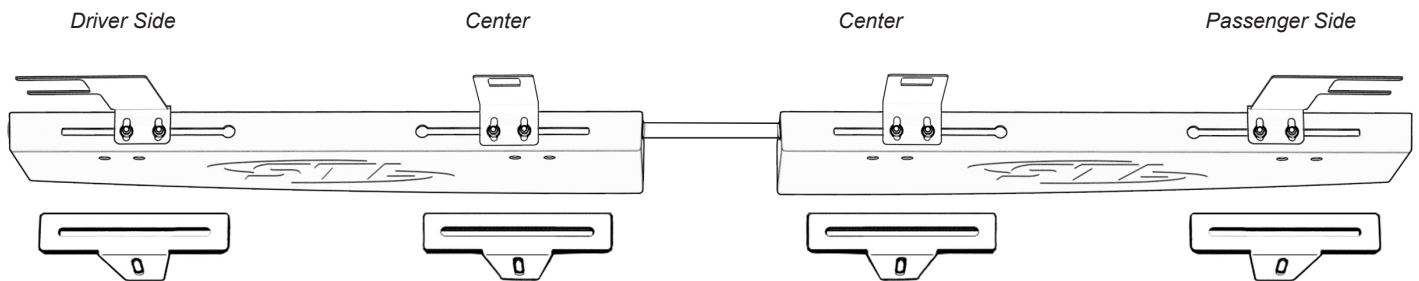

NOTE: Universal Base bracket can also be added for additional lateral and/or forward adjustment if necessary.

Q-RVE20: Ford Explorer (2020+)

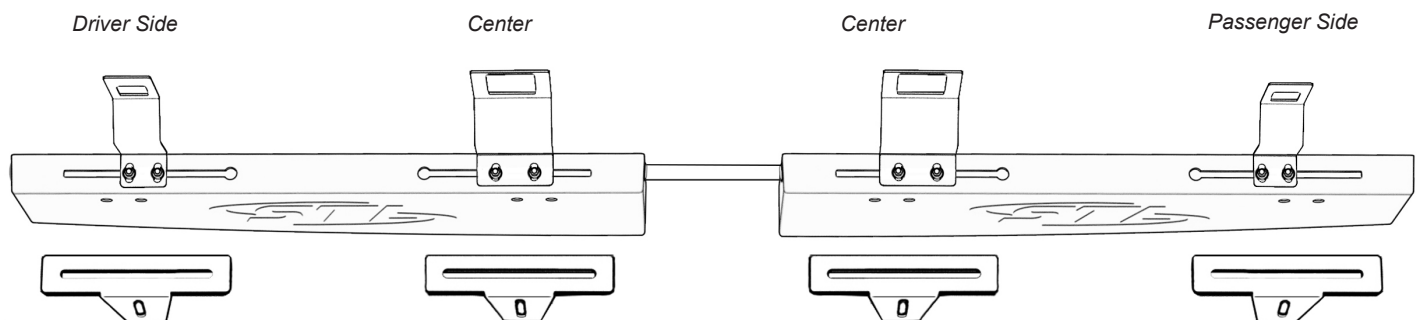

NOTE: Universal Base bracket can also be added for additional lateral and/or forward adjustment if necessary.

RAPTOR[®] SUPER TD VISOR LIGHT BAR

Q-RVEX18: Ford Expedition (2018+)

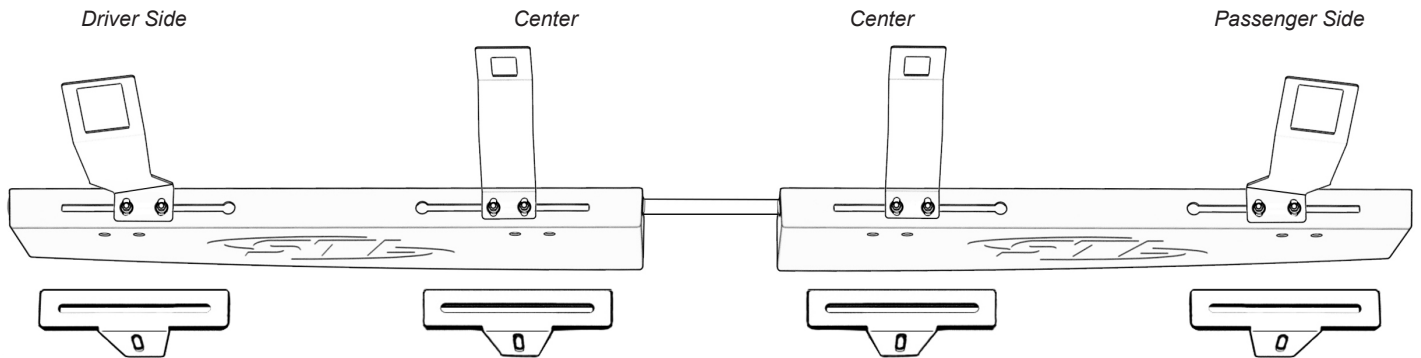

NOTE: Universal Base bracket can also be added for additional lateral and/or forward adjustment if necessary.

Q-RVIT11: Ford Taurus/Interceptor (2011+)

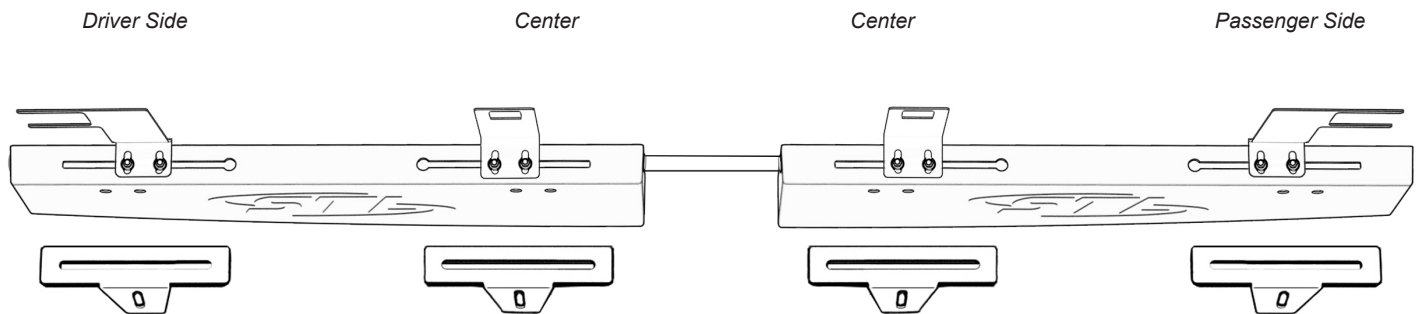

NOTE: Universal Base bracket can also be added for additional lateral and/or forward adjustment if necessary.

Q-RVT07: Chevy Tahoe/Silverado (2007-2014) GMC Yukon/Sierra 1500 (2007-2014)

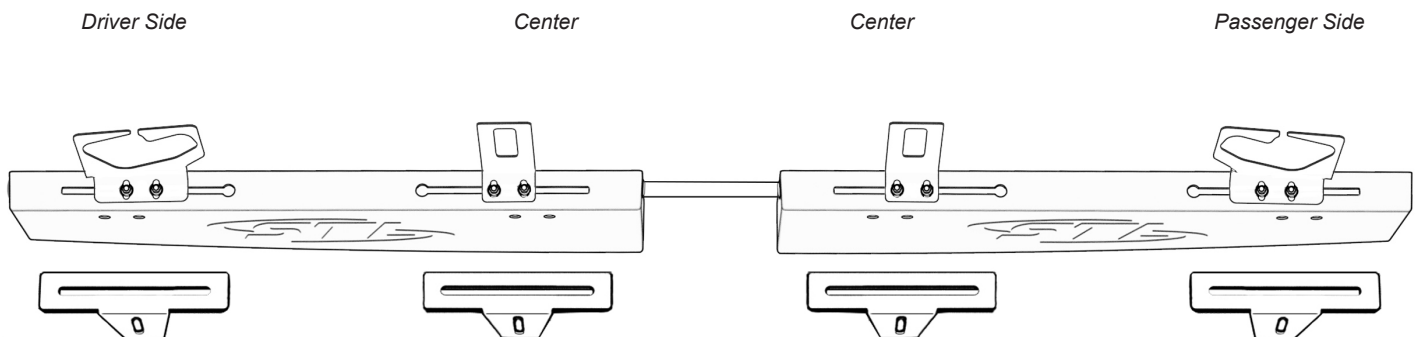

NOTE: Universal Base bracket can also be added for additional lateral and/or forward adjustment if necessary.

RAPTOR[®] SUPER TD VISOR LIGHT BAR

Q-RVT15: Chevy Tahoe/Silverado (2015+) GMC Yukon/Sierra 1500 (2015+)

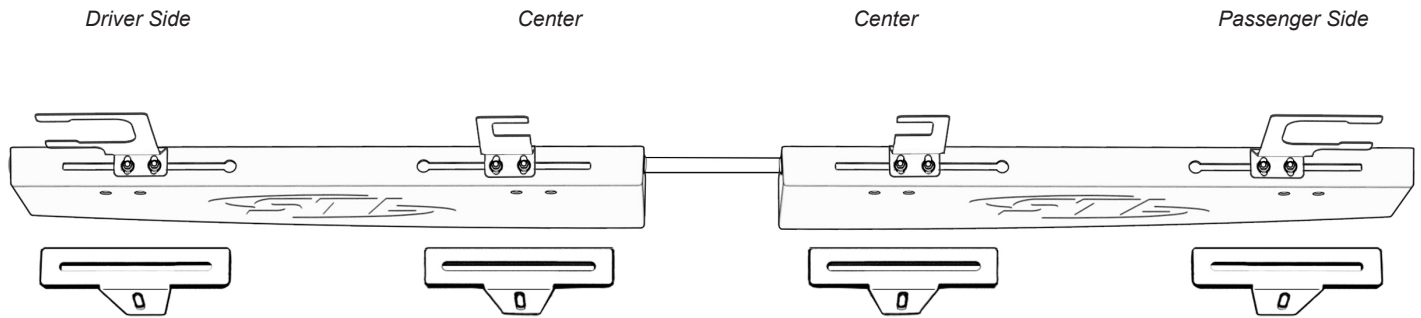

NOTE: Universal Base bracket can also be added for additional lateral and/or forward adjustment if necessary.

Q-RVC11: Dodge Charger (2011+)

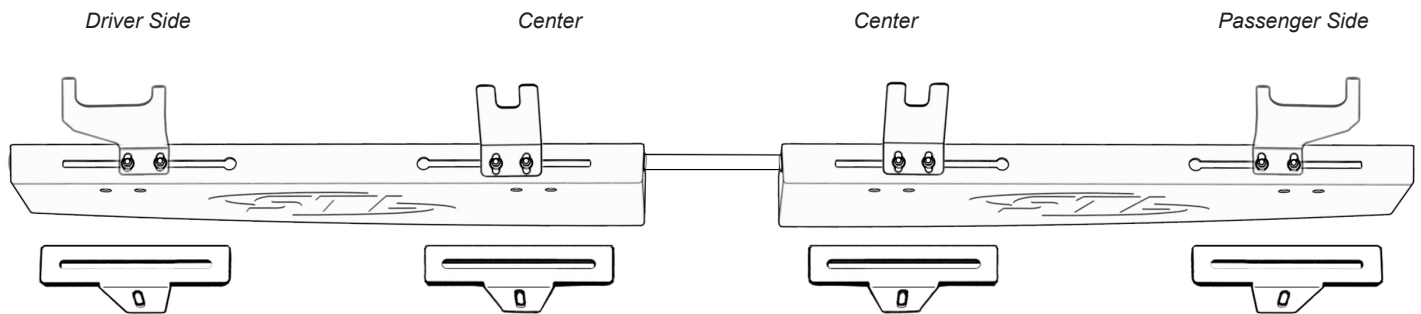

NOTE: Universal Base bracket can also be added for additional lateral and/or forward adjustment if necessary.

Q-RVR15: Dodge Ram (2015+)

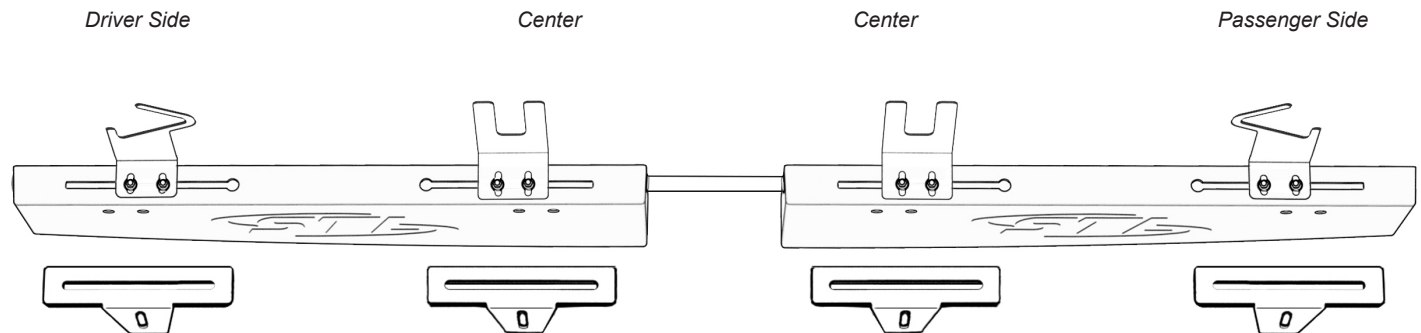

NOTE: Universal Base bracket can also be added for additional lateral and/or forward adjustment if necessary.

RAPTOR[®] SUPER TD VISOR LIGHT BAR

Q-RVD15: Dodge Durango (2015+)

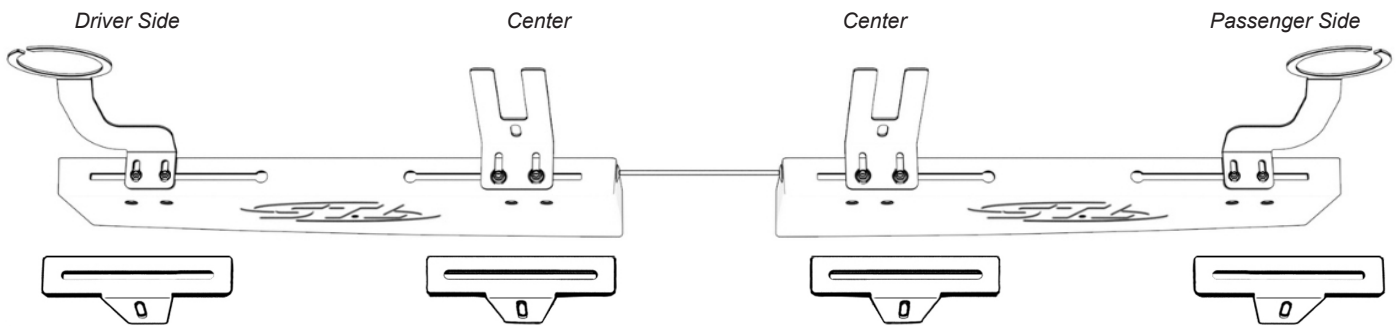

NOTE: Universal Base bracket can also be added for additional lateral and/or forward adjustment if necessary.

Q-RVE Raptor Visor Extender Installation (Sold Separately)

Includes:

- Driver and Passenger side extenders
- (8) Base screws
- (2) Rubber strips
- Double sided chatter guard tape squares

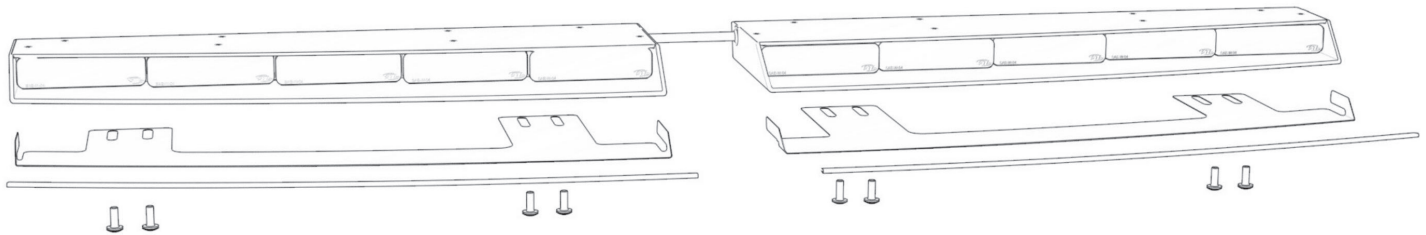

NOTE:

1. Take the visor extender and line up the wider side of the extender to the wider side of the Raptor.
2. Slide the extender over the lip of the Raptor so the prongs are seated on the interior of the Raptor housing.
3. Apply the rubber strip over the visor extender to prevent chatter and flash back.
4. Seat the Raptor to the windshield and make the appropriate adjustments so that the extender is flush with the windshield.
5. Apply the pieces of double sided chatter guard tape squares across the length of the extender to ensure tight contact with the Raptor housing to prevent chatter.
6. Use the base screws to secure the visor extender into final position.



RAPTOR® SUPER TD VISOR LIGHT BAR

Flash Pattern List

- Half-Half Slow
- Half-Half Medium
- Half-Half Fast
- Half-Half Medium->Fast
- Half-Half Triple Burst
- Alternating 1-1 Slow
- Alternating 1-1 Medium
- Alternating 1-1 Fast
- Alternating 1-1 Medium->Fast
- Alternating 1-1 Triple Burst
- Alternating 2-2 Slow
- Alternating 2-2 Medium
- Alternating 2-2 Fast
- Alternating 2-2 Medium->Fast
- Alternating 2-2 Triple Burst
- Full Slow
- Full Medium
- Full Fast
- Full Medium->Fast
- Full Triple Burst
- Night-Rider Double Sweep Slow
- Night-Rider Double Sweep Fast
- Double-Pong
- Half Steady A – Half Blink B
- Half Steady B – Half Blink A
- Half-Half -> Full Blink
- Alternating 1-2 Slow
- Alternating 1-2 Fast
- Combo-Patrol
- Combo-Rapid

Flash Pattern Shortcuts

- Hold for 3 seconds to toggle Steady Burn mode.
- Hold for 5 seconds to toggle Random pattern mode.

All rights reserved. No part of this Instruction Manual may be reproduced, distributed, transmitted, or otherwise shared in any form or by any means, including but not limited to photocopying, recording, electronic delivery, .PDF reproduction, or any other means of reproducing all or any part hereof without the express prior written consent of SpeedTech Lights, Inc, except for non-commercial purposes as permitted by United States copyright law. Customers of SpeedTech Lights, Inc, may download and print this Instruction Manual for use with products sold to the customer by SpeedTech Lights, Inc. However, no part of this Instruction Manual may be otherwise or subsequently reproduced, downloaded, disseminated, published, or transferred, in any form or by any means, except with the prior written consent of SpeedTech Lights, Inc.